

NOTES:

1. NOT TO SCALE
2. ALL DIMENSIONS ARE IN METERS OR UNLESS OTHERWISE SHOWN.
3. WHILE WE GUARANTEE THE QUALITY OF MATERIALS AND WORKMANSHIP USED IN THE MANUFACTURE OF FLEXICRETE, WE CANNOT GUARANTEE THAT IT WILL BE SUITABLE FOR ALL THE USES THAT CUSTOMERS MAY EXPECT IT TO PERFORM. EACH CLIENT MUST TAKE RESPONSIBILITY FOR THE INTENDED USE AND BE COMPLETELY SATISFIED THAT FLEXICRETE IS SUITABLE FOR SUCH USE.
4. ALL SUBGRADE SURFACES PREPARED FOR PLACEMENT OF MATS SHALL BE SMOOTH AND FREE OF ALL ROCKS, STICKS, ROOTS, OTHER PROTRUSIONS, OR DEBRIS OF ANY KIND. THE PREPARED SURFACE SHALL PROVIDE A FIRM UNYIELDING FOUNDATION FOR THE MATS WITH NO SHARP OR ABRUPT BREAKS IN THE GRADE.

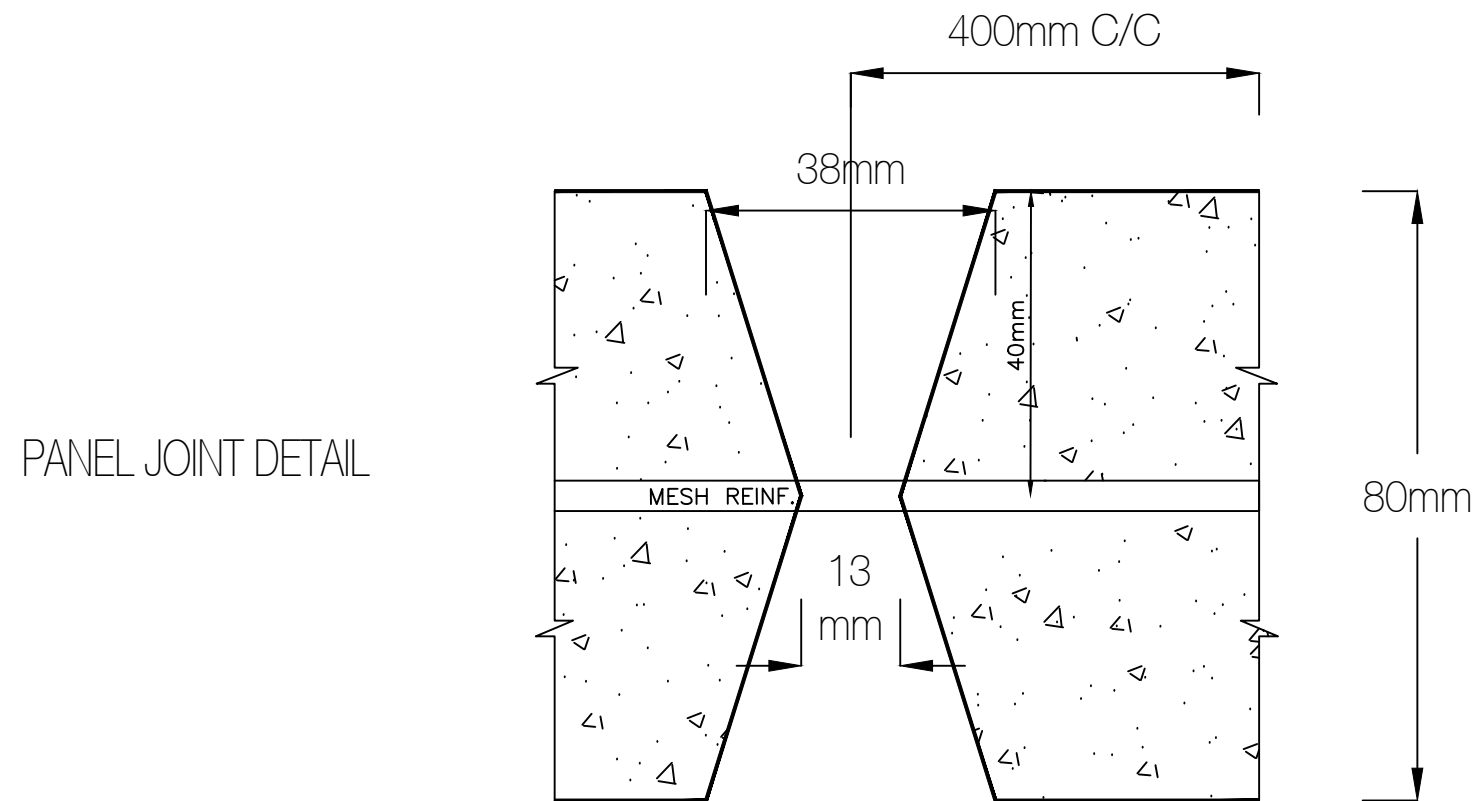
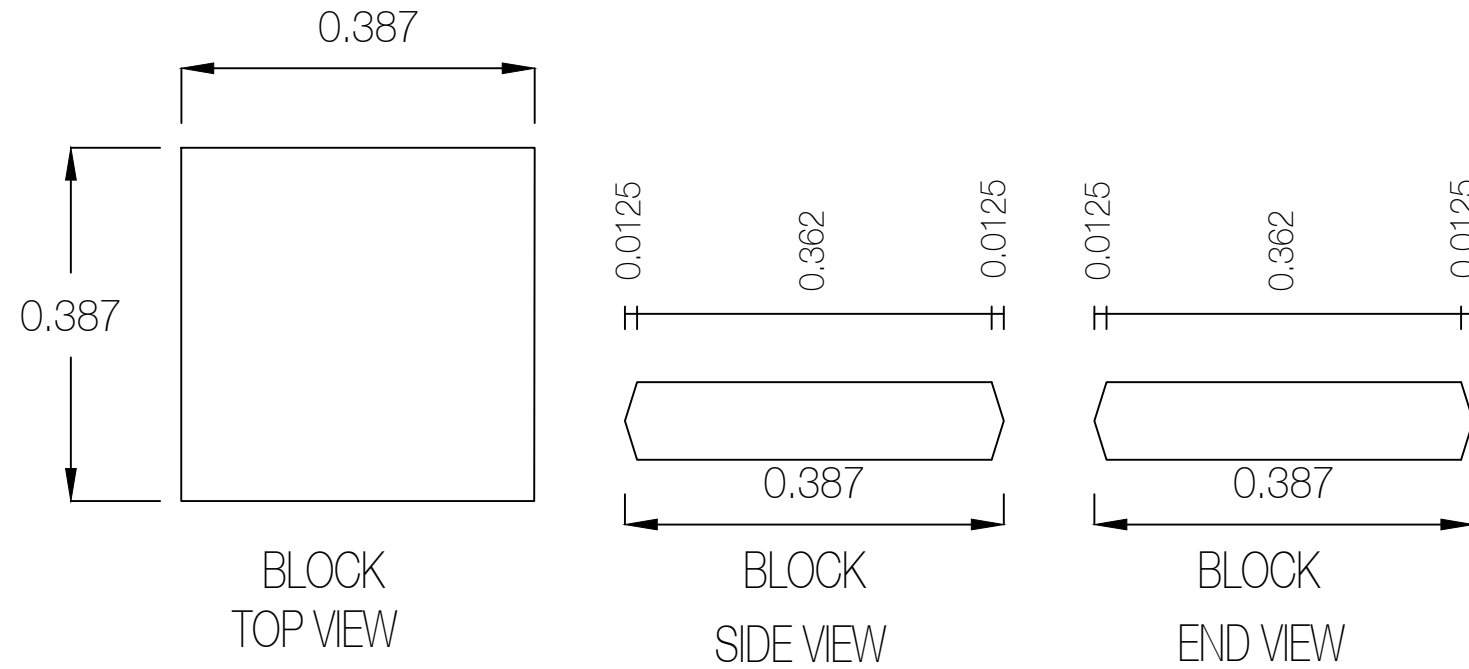

REVISIONS \ ISSUE

NO.	DESCRIPTION	DATE

Project Number
Date Drawn 05/08/2017
Scale N.T.S.
Designed by
Drawn by
Checked by

**NOTES:**

1. NOT TO SCALE
2. ALL DIMENSIONS ARE IN METERS OR UNLESS OTHERWISE SHOWN.
3. WHILE WE GUARANTEE THE QUALITY OF MATERIALS AND WORKMANSHIP USED IN THE MANUFACTURE OF FLEXICRETE, WE CANNOT GUARANTEE THAT IT WILL BE SUITABLE FOR ALL THE USES THAT CUSTOMERS MAY EXPECT IT TO PERFORM. EACH CLIENT MUST TAKE RESPONSIBILITY FOR THE INTENDED USE AND BE COMPLETELY SATISFIED THAT FLEXICRETE IS SUITABLE FOR SUCH USE.
4. ALL SUBGRADE SURFACES PREPARED FOR PLACEMENT OF MATS SHALL BE SMOOTH AND FREE OF ALL ROCKS, STICKS, ROOTS, OTHER PROTRUSIONS, OR DEBRIS OF ANY KIND. THE PREPARED SURFACE SHALL PROVIDE A FIRM UNYIELDING FOUNDATION FOR THE MATS WITH NO SHARP OR ABRUPT BREAKS IN THE GRADE.

**FLEXICRETE® SPECIFICATIONS:**

- CONCRETE STRENGTH USED IS 30 MPa OR HIGHER IN ACCORDANCE WITH CANADIAN STANDARDS CSA-A23
- THE GALVANIZED MESH REINFORCEMENT WIRES ARE 203mm CENTRE TO CENTRE AND 4.12mm DIAMETER (8/8 GAUGE)
- THE CROSS-SECTIONAL AREA OF STEEL IN LONGITUDINAL AND TRANSVERSE DIRECTION IS 65.69mm<sup>2</sup>/m FOR 8/8 GAUGE.

**FLEXICRETE® SIZES:**

- BLOCKS ARE AT 400mm CENTRES
- STANDARD BLOCK WEIGHS 27kg
- PANEL UNIT WEIGHT IS 168 kg/m<sup>2</sup>
- STANDARD PANEL WEIGHS 1.45 TONNES

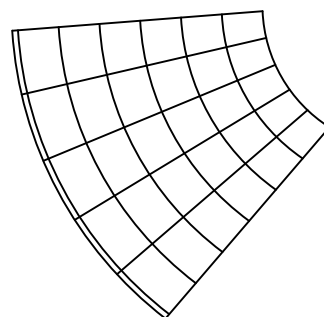

FLEXICRETE®

$\frac{1}{4}$ " DIA. GALVANIZED LIFT HOOKS

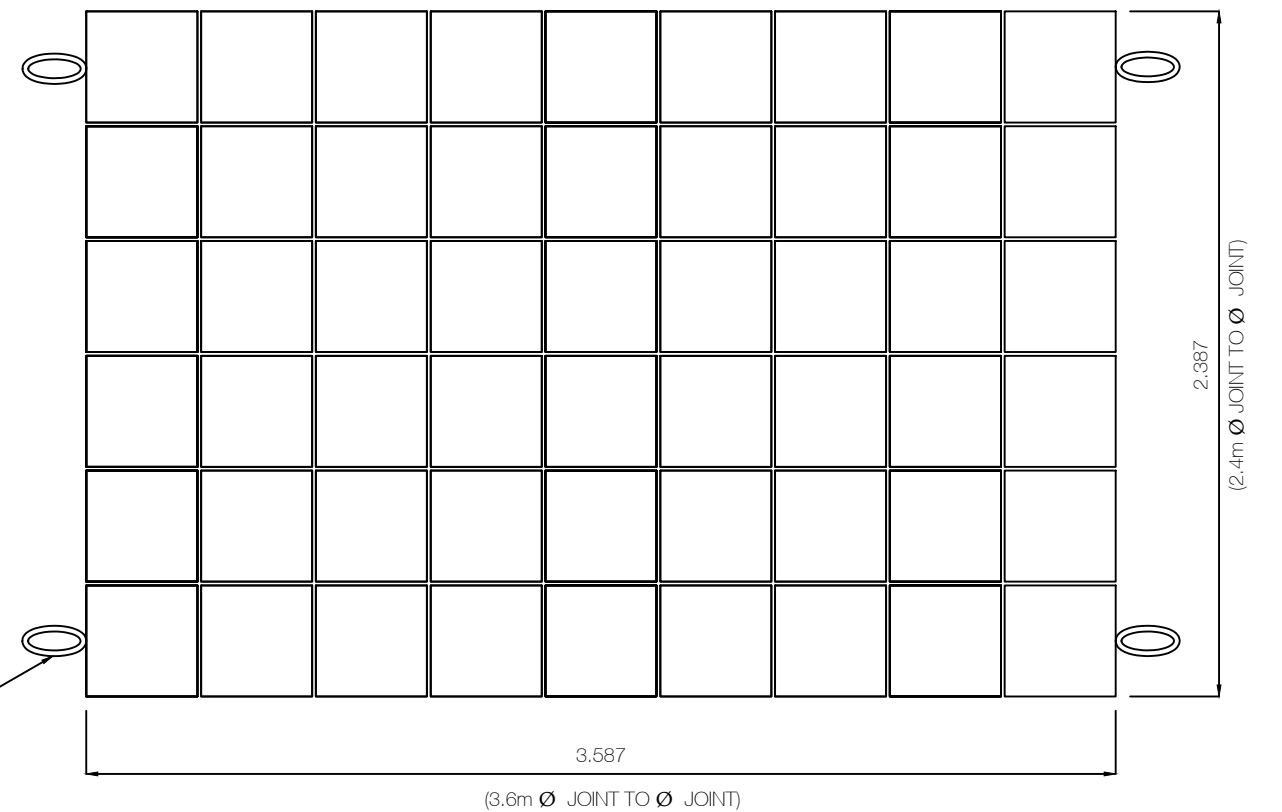
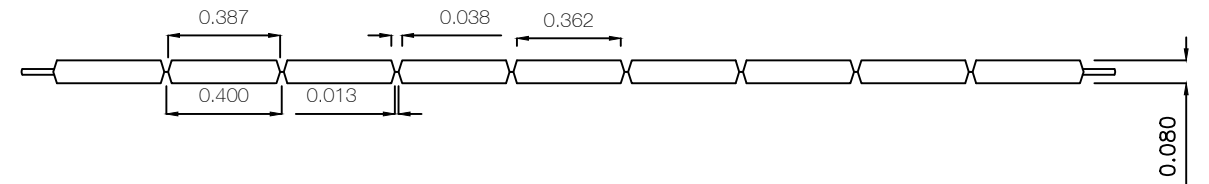

**REVISIONS \ ISSUE**

NO.	DATE	DESCRIPTION

Project Number

Date Drawn  
05/08/2017

Scale  
N.T.S.

Designed by

Drawn by

Checked by

FLEXICRETE®

**NOTES:**

1. NOT TO SCALE
2. ALL DIMENSIONS ARE IN METERS OR UNLESS OTHERWISE SHOWN.
3. WHILE WE GUARANTEE THE QUALITY OF MATERIALS AND WORKMANSHIP USED IN THE MANUFACTURE OF FLEXICRETE, WE CANNOT GUARANTEE THAT IT WILL BE SUITABLE FOR ALL THE USES THAT CUSTOMERS MAY EXPECT IT TO PERFORM. EACH CLIENT MUST TAKE RESPONSIBILITY FOR THE INTENDED USE AND BE COMPLETELY SATISFIED THAT FLEXICRETE IS SUITABLE FOR SUCH USE.
4. ALL SUBGRADE SURFACES PREPARED FOR PLACEMENT OF MATS SHALL BE SMOOTH AND FREE OF ALL ROCKS, STICKS, ROOTS, OTHER PROTRUSIONS, OR DEBRIS OF ANY KIND. THE PREPARED SURFACE SHALL PROVIDE A FIRM UNYIELDING FOUNDATION FOR THE MATS WITH NO SHARP OR ABRUPT BREAKS IN THE GRADE.

**FLEXICRETE® SPECIFICATIONS:**

- CONCRETE STRENGTH USED IS 30 MPa OR HIGHER IN ACCORDANCE WITH CANADIAN STANDARDS CSA-A23
- THE GALVANIZED MESH REINFORCEMENT WIRES ARE 203mm CENTRE TO CENTRE AND 4.12mm DIAMETER (8/8 GAUGE)
- THE CROSS-SECTIONAL AREA OF STEEL IN LONGITUDINAL AND TRANSVERSE DIRECTION IS 65.69mm<sup>2</sup>/m FOR 8/8 GAUGE.

**FLEXICRETE® SIZES:**

- BLOCKS ARE AT 400mm CENTRES
- STANDARD BLOCK WEIGHS 27kg
- PANEL UNIT WEIGHT IS 168 kg/m<sup>2</sup>
- STANDARD PANEL WEIGHS 1.45 TONNES

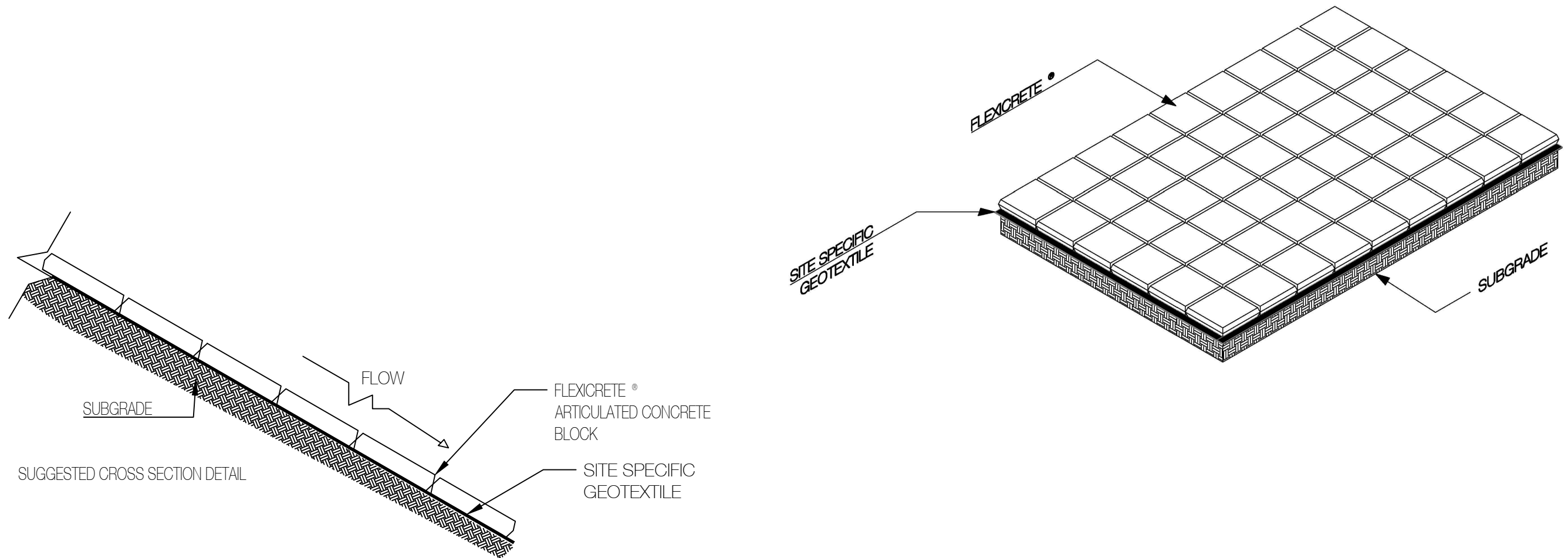

COPYRIGHT 2017, TERRAFIX GEOSYNTHETICS INC.

**terrafix**  
geosynthetics inc.  
455 Horner Avenue  
Toronto, Ontario  
M8W 4W9  
Tel:(416) 674-0363

**REVISIONS \ ISSUE**

NO.	REVISIONS \ ISSUE

Project Number
Date Drawn 05/08/2017
Scale N.T.S.
Designed by
Drawn by
Checked by

FLEXICRETE®

NON-HYDRAULIC APPLICATION  
CROSS SECTION VIEW

Sheet Number  
3 OF 4

NOTES:

1. NOT TO SCALE
2. ALL DIMENSIONS ARE IN METERS OR UNLESS OTHERWISE SHOWN.
3. WHILE WE GUARANTEE THE QUALITY OF MATERIALS AND WORKMANSHIP USED IN THE MANUFACTURE OF FLEXICRETE, WE CANNOT GUARANTEE THAT IT WILL BE SUITABLE FOR ALL THE USES THAT CUSTOMERS MAY EXPECT IT TO PERFORM. EACH CLIENT MUST TAKE RESPONSIBILITY FOR THE INTENDED USE AND BE COMPLETELY SATISFIED THAT FLEXICRETE IS SUITABLE FOR SUCH USE.
4. ALL SUBGRADE SURFACES PREPARED FOR PLACEMENT OF MATS SHALL BE SMOOTH AND FREE OF ALL ROCKS, STICKS, ROOTS, OTHER PROTRUSIONS, OR DEBRIS OF ANY KIND. THE PREPARED SURFACE SHALL PROVIDE A FIRM UNYIELDING FOUNDATION FOR THE MATS WITH NO SHARP OR ABRUPT BREAKS IN THE GRADE.

FLEXICRETE® SPECIFICATIONS:

- CONCRETE STRENGTH USED IS 30 MPa OR HIGHER IN ACCORDANCE WITH CANADIAN STANDARDS CSA-A23
- THE GALVANIZED MESH REINFORCEMENT WIRES ARE 203mm CENTRE TO CENTRE AND 4.12mm DIAMETER (8/8 GAUGE)
- THE CROSS-SECTIONAL AREA OF STEEL IN LONGITUDINAL AND TRANSVERSE DIRECTION IS 65.69mm<sup>2</sup>/m FOR 8/8 GAUGE.

FLEXICRETE® SIZES:

- BLOCKS ARE AT 400mm CENTRES
- STANDARD BLOCK WEIGHS 27kg
- PANEL UNIT WEIGHT IS 168 kg/m<sup>2</sup>
- STANDARD PANEL WEIGHS 1.45 TONNES

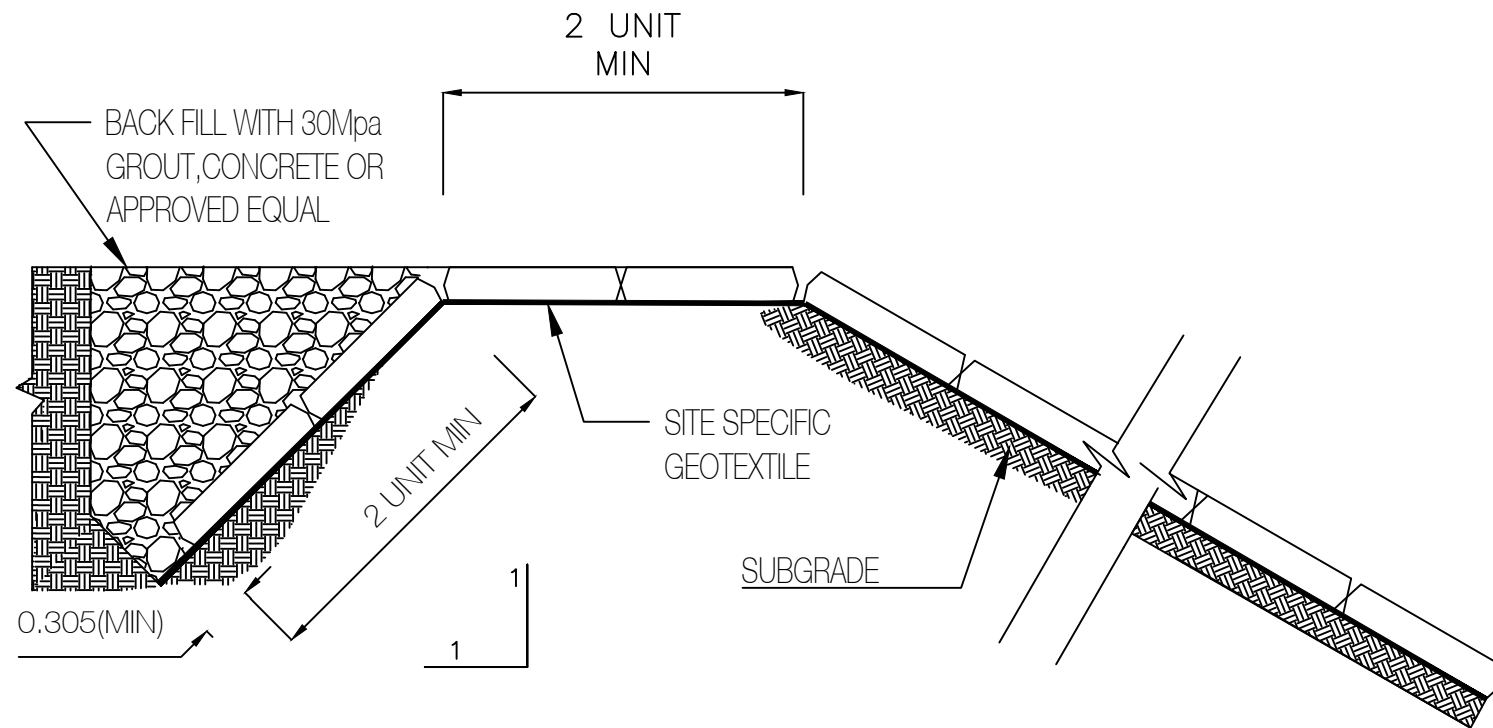
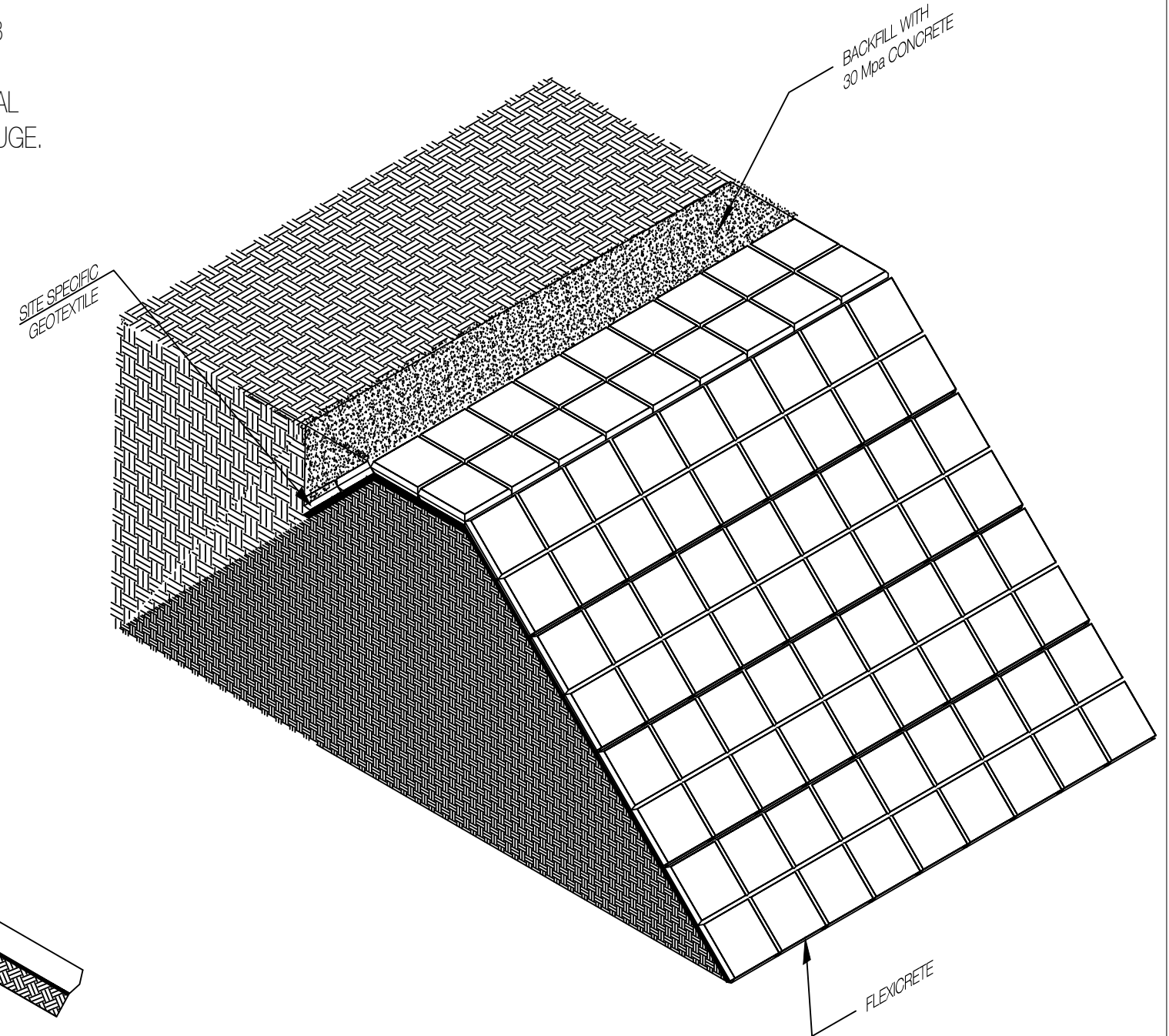

REVISIONS \ ISSUE

NO.	DESCRIPTION	DATE

Project Number
Date Drawn 05/08/2017
Scale N.T.S.
Designed by
Drawn by
Checked by

CROSS - SECTION

NON-HYDRAULIC APPLICATION